

Description

The EN6360QI is a Power System on a Chip (PowerSoC) DC to DC converter with an integrated inductor, PWM controller, MOSFETs and compensation to provide the smallest solution size in an 8x11x3mm 68 pin QFN module. It offers high efficiency, excellent line and load regulation over temperature and up to the full 8A load range. The EN6360QI is specifically designed to meet the precise voltage and fast transient requirements of high-performance, low-power processor, DSP, FPGA, memory boards and system level applications in distributed power architecture. The EN6360QI features switching frequency synchronization with an external clock or other EN6360QIs for parallel operation. Other features include precision enable threshold, pre-bias monotonic start-up, and programmable soft-start. The device's advanced circuit techniques, ultra high switching frequency, and proprietary integrated inductor technology deliver high-quality, ultra compact, non-isolated DC-DC conversion.

The Enpirion integrated inductor solution significantly helps to reduce noise. The complete power converter solution enhances productivity by offering greatly simplified board design, layout and manufacturing requirements. All Enpirion products are RoHS compliant and lead-free manufacturing environment compatible.

Features

- High Efficiency (Up to 96%)
- Excellent Ripple and EMI Performance
- Up to 8A Continuous Operating Current
- Input Voltage Range (2.5V to 6.6V)
- Frequency Synchronization (Clock or Primary)
- 2% V_{OUT} Accuracy (Over Line/Load/Temperature)
- Optimized Total Solution Size (190mm²)
- Precision Enable Threshold for Sequencing
- Programmable Soft-Start
- Master/Slave Configuration for Parallel Operation
- Thermal Shutdown, Over-Current, Short Circuit, and Under-Voltage Protection
- RoHS Compliant, MSL Level 3, 260°C Reflow

Applications

- Point of Load Regulation for Low-Power, ASICs Multi-Core and Communication Processors, DSPs, FPGAs and Distributed Power Architectures
- Blade Servers, RAID Storage and LAN/SAN Adapter Cards, Wireless Base Stations, Industrial Automation, Test and Measurement, Embedded Computing, and Printers
- High Efficiency 12V Intermediate Bus Architectures
- Beat Frequency/Noise Sensitive Applications

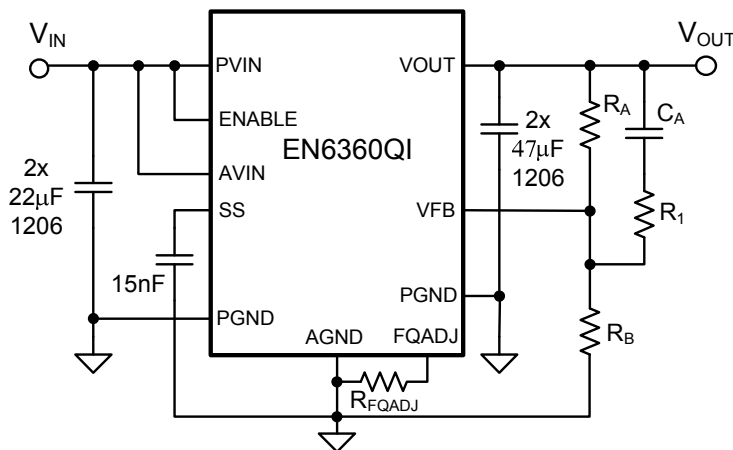

Figure 1. Simplified Applications Circuit

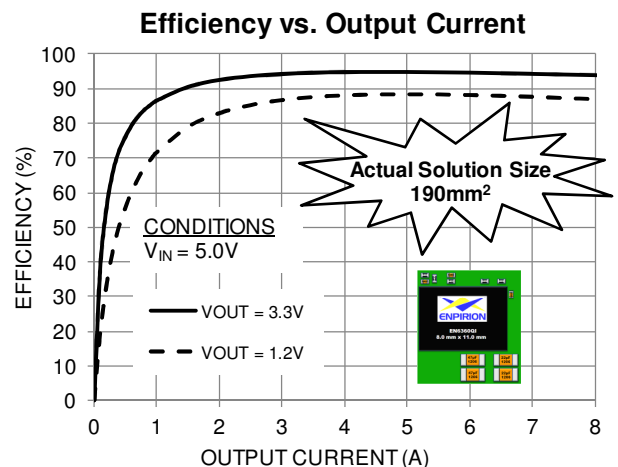

Figure 2. Highest Efficiency in Smallest Solution Size

Ordering Information

Part Number	Package Markings	Temp Rating (°C)	Package Description
EN6360QI	EN6360QI	-40 to +85	68-pin (8mm x 11mm x 3mm) QFN T&R
EN6360QI-E	EN6360QI		QFN Evaluation Board

Packing and Marking Information: <http://www.enpirion.com/resource-center-packing-and-marking-information.htm>

Pin Assignments (Top View)

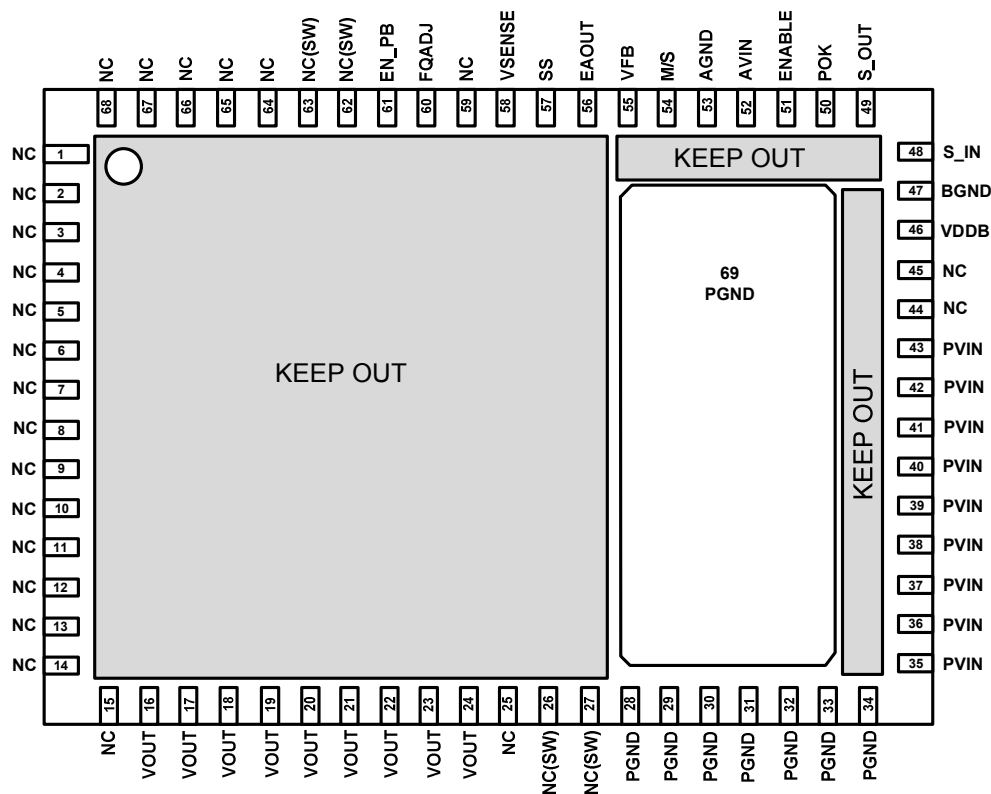

Figure 3: Pin Out Diagram (Top View)

NOTE A: NC pins are not to be electrically connected to each other or to any external signal, ground, or voltage. However, they must be soldered to the PCB. Failure to follow this guideline may result in part malfunction or damage.

NOTE B: Shaded area highlights exposed metal below the package that is not to be mechanically or electrically connected to the PCB. Refer to Figure 11 for details.

NOTE C: White 'dot' on top left is pin 1 indicator on top of the device package.

Pin Description

PIN	NAME	FUNCTION
1-15, 25, 44-45, 59, 64-68	NC	NO CONNECT: These pins must be soldered to PCB but not electrically connected to each other or to any external signal, voltage, or ground. These pins may be connected internally. Failure to follow this guideline may result in device damage.
16-24	VOUT	Regulated converter output. Connect to the load and place output filter capacitor(s) between these pins and PGND pins 28 to 31.

PIN	NAME	FUNCTION
26-27, 62-63	NC(SW)	NO CONNECT: These pins are internally connected to the common switching node of the internal MOSFETs. They must be soldered to PCB but not be electrically connected to any external signal, ground, or voltage. Failure to follow this guideline may result in device damage.
28-34	PGND	Input and output power ground. Connect these pins to the ground electrode of the input and output filter capacitors. Refer to VOUT, PVIN descriptions and Layout Recommendation for more details.
35-43	PVIN	Input power supply. Connect to input power supply and place input filter capacitor(s) between these pins and PGND pins 32 to 34.
46	VDDDB	Internal regulated voltage used for the internal control circuitry. Decouple with an optional 0.1 μ F capacitor to BGND for improved efficiency. This pin may be left floating if board space is limited.
47	BGND	Ground for VDDDB. Refer to pin 46 description.
48	S_IN	Digital input. A high level on the M/S pin will make this EN6360QI a Slave and the S_IN will accept the S_OUT signal from another EN6360QI for parallel operation. A low level on the M/S pin will make this device a Master and the switching frequency will be phase locked to an external clock. Leave this pin floating if it is not used.
49	S_OUT	Digital output. A low level on the M/S pin will make this EN6360QI a Master and the internal switching PWM signal is output on this pin. This output signal is connected to the S_IN pin of another EN6360QI device for parallel operation. Leave this pin floating if it is not used.
50	POK	POK is a logic level high when VOUT is within -10% to +20% of the programmed output voltage ($0.9V_{OUT_NOM} \leq V_{OUT} \leq 1.2V_{OUT_NOM}$). This pin has an internal pull-up resistor to AVIN with a nominal value of 120k Ω .
51	ENABLE	Device enable pin. A high level or floating this pin enables the device while a low level disables the device. A voltage ramp from another power converter may be applied for precision enable. Refer to Power Up Sequencing
52	AVIN	Analog input voltage for the control circuits. Connect this pin to the input power supply (PVIN) at a quiet point. Can also be connected to an auxiliary supply within a voltage range that is sequencing.
53	AGND	The quiet ground for the control circuits. Connect to the ground plane with a via right next to the pin.
54	M/S	Ternary (three states) input pin. Floating this pin disables parallel operation. A low level configures the device as Master and a high level configures the device as a Slave. A R _{EXT} resistor is recommended to pulling M/S high. Refer to Ternary Pin description in the Functional Description section for R _{EXT} values. Also refer to S_IN and S_OUT pin descriptions.
55	VFB	This is the external feedback input pin. A resistor divider connects from the output to AGND. The mid-point of the resistor divider is connected to VFB. A feed-forward capacitor (C _A) and resistor (R1) are required parallel to the upper feedback resistor (R _A). The output voltage regulation is based on the VFB node voltage equal to 0.600V. For Slave devices, leave VFB floating.
56	EAOUT	Error amplifier output. Allows for customization of the control loop. May be left floating.
57	SS	A soft-start capacitor is connected between this pin and AGND. The value of the capacitor controls the soft-start interval. Refer to Soft-Start in the Functional Description for more details.
58	VSENSE	This pin senses output voltage when the device is in pre-bias (or back-feed) mode. Connect VSENSE to VOUT when EN_PB is high or floating. Leave floating when EN_PB is low.
60	FQADJ	Frequency adjust pin. This pin must have a resistor to AGND which sets the free running frequency of the internal oscillator.
61	EN_PB	Enable pre-bias input. When this pin is pulled high, the device will support monotonic start-up under a pre-biased load. VSENSE must be tied to VOUT for EN_PB to function. This pin is pulled high internally. Enable pre-bias feature is not available for parallel operations.
69	PGND	Not a perimeter pin. Device thermal pad to be connected to the system GND plane for heat-sinking purposes. Refer to Layout Recommendation section.

Absolute Maximum Ratings

CAUTION: Absolute Maximum ratings are stress ratings only. Functional operation beyond the recommended operating conditions is not implied. Stress beyond the absolute maximum ratings may impair device life. Exposure to absolute maximum rated conditions for extended periods may affect device reliability.

PARAMETER	SYMBOL	MIN	MAX	UNITS
Voltages on : PVIN, AVIN, VOUT		-0.3	7.0	V
Voltages on: EN, POK, M/S		-0.3	$V_{IN}+0.3$	V
Voltages on: VFB, EXTREF, EAOUT, SS, S_IN, S_OUT, FQADJ		-0.3	2.5	V
Storage Temperature Range	T_{STG}	-65	150	°C
Maximum Operating Junction Temperature	$T_{J-ABS Max}$		150	°C
Reflow Temp, 10 Sec, MSL3 JEDEC J-STD-020A			260	°C
ESD Rating (based on Human Body Model)			2000	V
ESD Rating (based on CDM)			500	V

Recommended Operating Conditions

PARAMETER	SYMBOL	MIN	MAX	UNITS
Input Voltage Range	V_{IN}	2.5	6.6	V
Output Voltage Range (Note 1)	V_{OUT}	0.60	$V_{IN} - V_{DO}$	V
Output Current	I_{OUT}		8	A
Operating Ambient Temperature	T_A	-40	+85	°C
Operating Junction Temperature	T_J	-40	+125	°C

Thermal Characteristics

PARAMETER	SYMBOL	TYP	UNITS
Thermal Resistance: Junction to Ambient (0 LFM) (Note 2)	θ_{JA}	15	°C/W
Thermal Resistance: Junction to Case (0 LFM)	θ_{JC}	1.0	°C/W
Thermal Shutdown	T_{SD}	150	°C
Thermal Shutdown Hysteresis	T_{SDH}	20	°C

Note 1: V_{DO} (dropout voltage) is defined as ($I_{LOAD} \times \text{Dropout Resistance}$). Please refer to Electrical Characteristics Table.

Note 2: Based on 2oz. external copper layers and proper thermal design in line with EIJ/JEDEC JESD51-7 standard for high thermal conductivity boards.

Electrical Characteristics

NOTE: $V_{IN}=6.6V$, Minimum and Maximum values are over operating ambient temperature range unless otherwise noted. Typical values are at $T_A = 25^\circ C$.

PARAMETER	SYMBOL	TEST CONDITIONS	MIN	TYP	MAX	UNITS
Operating Input Voltage	V_{IN}		2.5		6.6	V
VFB Pin Voltage	V_{VFB}	Internal Voltage Reference at: $V_{IN} = 5V$, $I_{LOAD} = 0$, $T_A = 25^\circ C$	0.594	0.600	0.606	V
VFB Pin Voltage (Line, Load and Temperature)	V_{VFB}	$2.5V \leq V_{IN} \leq 6.6V$ $0A \leq I_{LOAD} \leq 8A$	0.588	0.600	0.612	V
VFB Pin Input Leakage Current	I_{VFB}	VFB Pin Input Leakage Current	-0.2		0.2	μA
Shut-Down Supply Current	I_S	Power Supply Current with ENABLE=0		1.5		mA
Under Voltage Lock-out – V_{IN} Rising	V_{UVLOR}	Voltage Above Which UVLO is Not Asserted		2.2		V
Under Voltage Lock-out – V_{IN} Falling	V_{UVLOF}	Voltage Below Which UVLO is Asserted		2.1		V
Drop Out Voltage	V_{DO}	$V_{INMIN} - V_{OUT}$ at Full Load		400	800	mV
Drop Out Resistance	R_{DO}	Input to Output Resistance		50	100	m Ω
Continuous Output Current	I_{OUT_SRC}		0		8	A
Over Current Trip Level	I_{OCP}	Sourcing Current		16		A
Switching Frequency	F_{SW}	$R_{FADJ} = 4.42 k\Omega$, $V_{IN} = 5V$	0.9	1.2	1.5	MHz
External SYNC Clock Frequency Lock Range	F_{PLL_LOCK}	SYNC Clock Input Frequency Range	$0.9 * F_{sw}$	F_{sw}	$1.1 * F_{sw}$	MHz
S_IN Clock Amplitude – Low	$V_{S_IN_LO}$	SYNC Clock Logic Low	0		0.8	V
S_IN Clock Amplitude – High	$V_{S_IN_HI}$	SYNC Clock Logic High	1.8		2.5	V
S_IN Clock Duty Cycle (PLL)	DC_{S_INPLL}	M/S Pin Float or Low	20		80	%
S_IN Clock Duty Cycle (PWM)	DC_{S_INPWM}	M/S Pin High	10		90	%
Pre-Bias Level	V_{PB}	Allowable Pre-bias as a Fraction of Programmed Output Voltage for Monotonic start up. Minimum Pre-bias Voltage = 300mV.	20		75	%
Non-Monotonicity	V_{PB_NM}	Allowable Non-monotonicity Under Pre-bias Startup		100		mV
V_{OUT} Range for $P_{OK} = High$		Range of Output Voltage as a Fraction of Programmed Value When P_{OK} is Asserted. (Note 3)	90		120	%

PARAMETER	SYMBOL	TEST CONDITIONS	MIN	TYP	MAX	UNITS
P _{OK} Deglitch Delay		Falling Edge Deglitch Delay After Output Crossing 90% level. F _{SW} =1.2 MHz		213		μs
V _{POK} Logic Low level		With 4mA Current Sink into P _{OK} Pin			0.4	V
V _{POK} Logic high level				V _{IN}		V
POK Internal pull-up resistor				94		kΩ
Current Balance	ΔI _{OUT}	With 2 to 4 Converters in Parallel, the Difference Between Nominal and Actual Current Levels. ΔV _{IN} <50mV; R _{TRACE} < 10 mΩ, I _{load} = # Converter * I _{MAX}		+/-10		%
V _{OUT} Rise Time Accuracy	ΔT _{RISE} (Note 4)	t _{RISE} [ms] = C _{SS} [nF] x 0.065; 10nF ≤ C _{SS} ≤ 30nF; (Note 5 and Note 6)	-25		+25	%
ENABLE Logic High	V _{ENABLE_HIGH}	2.5V ≤ V _{IN} ≤ 6.6V;	1.2		V _{IN}	V
ENABLE Logic Low	V _{ENABLE_LOW}		0		0.8	V
ENABLE Pin Current	I _{EN}	V _{IN} = 6.6V		50		μA
M/S Ternary Pin Logic Low	V _{T-LOW}	Tie M/S Pin to GND	0		0.7	V
M/S Ternary Pin Logic Float	V _{T-FLOAT}	M/S Pin is Open	1.1		1.4	V
M/S Ternary Pin Logic Hi (Note 7)	V _{T-HIGH}	Pull Up to V _{IN} through an external resistor R _{EXT} . Refer to Figure 7.	1.8			V
Ternary Pin Input Current	I _{TERN}	2.5V ≤ V _{IN} ≤ 4V, R _{EXT} = 15kΩ 4V < V _{IN} ≤ 6.6V, R _{EXT} = 51kΩ			117 88	μA
Binary Pin Logic Low Threshold	V _{B-LOW}	ENABLE, S_IN			0.8	V
Binary Pin Logic High Threshold	V _{B-HIGH}	ENABLE, S_IN	1.8			V
S_OUT Low Level	V _{S_OUT_LOW}				0.4	V
S_OUT High Level	V _{S_OUT_HIGH}		2.0			V

Note 3: POK threshold when V_{OUT} is rising is nominally 92%. This threshold is 90% when V_{OUT} is falling. After crossing the 90% level, there is a 256 clock cycle (~213μs at 1.2 MHz) delay before POK is de-asserted. The 90% and 92% levels are nominal values. Expect these thresholds to vary by ±3%.

Note 4: Parameter not production tested but is guaranteed by design.

Note 5: Rise time calculation begins when AV_{IN} > V_{UVLO} and ENABLE = HIGH.

Note 6: V_{OUT} Rise Time Accuracy does not include soft-start capacitor tolerance..

Note 7: M/S pin is ternary. Ternary pins have three logic levels: high, float, and low. This pin is meant to be strapped to V_{IN} through an external resistor, strapped to GND, or left floating. The state cannot be changed while the device is on.

Typical Performance Curves

Efficiency vs. Output Current

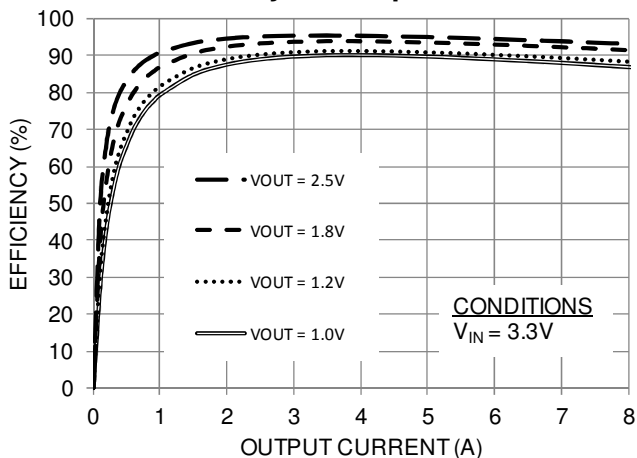

Efficiency vs. Output Current

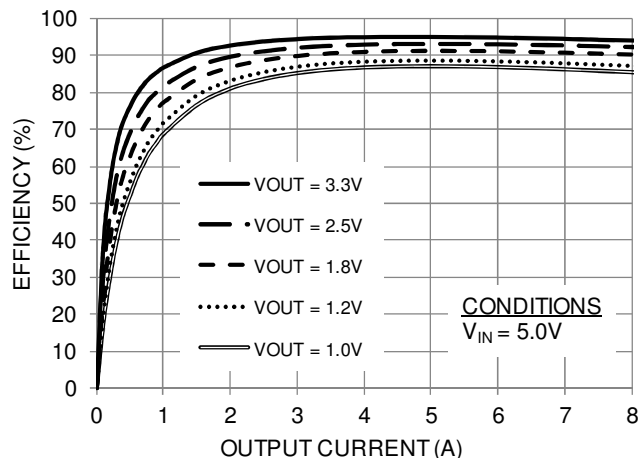

Output Voltage vs. Output Current

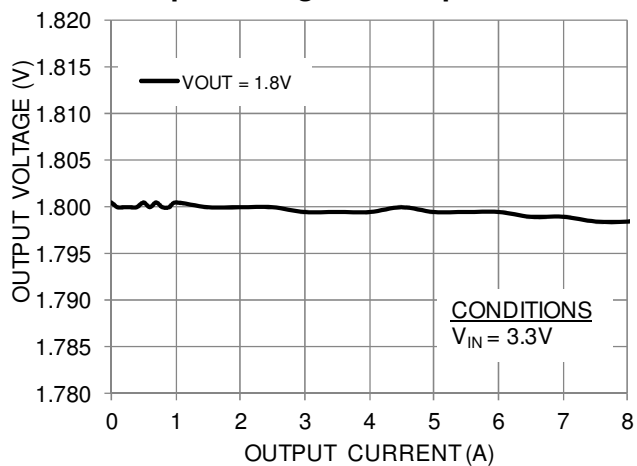

Output Voltage vs. Output Current

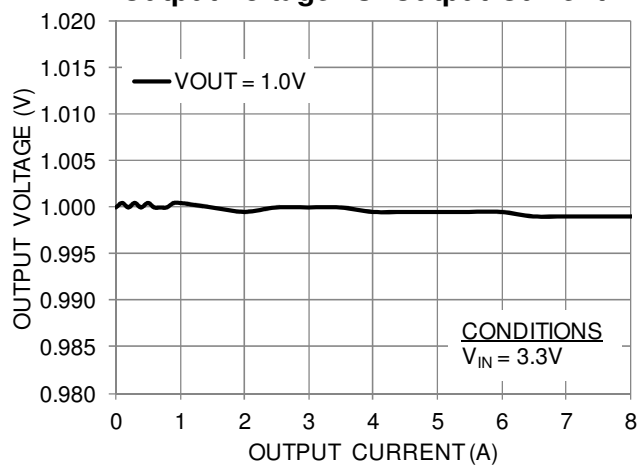

Output Voltage vs. Output Current

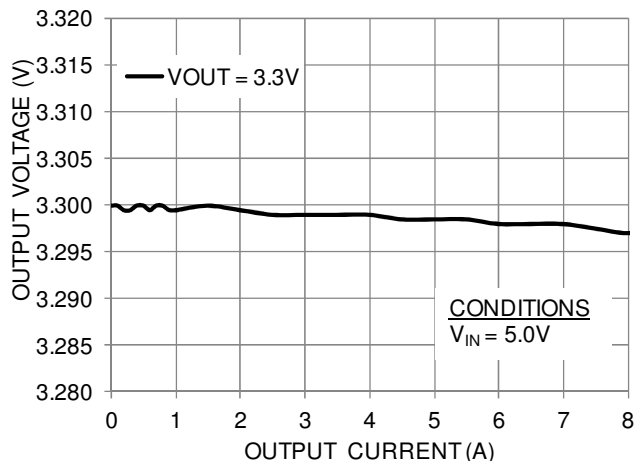

Output Voltage vs. Output Current

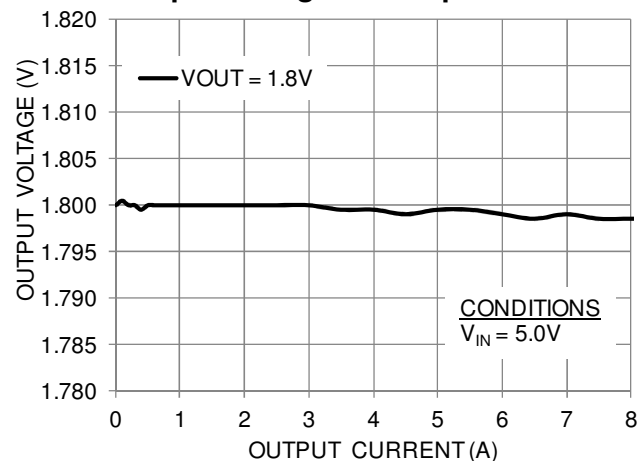

Typical Performance Curves (Continued)

Output Voltage vs. Output Current

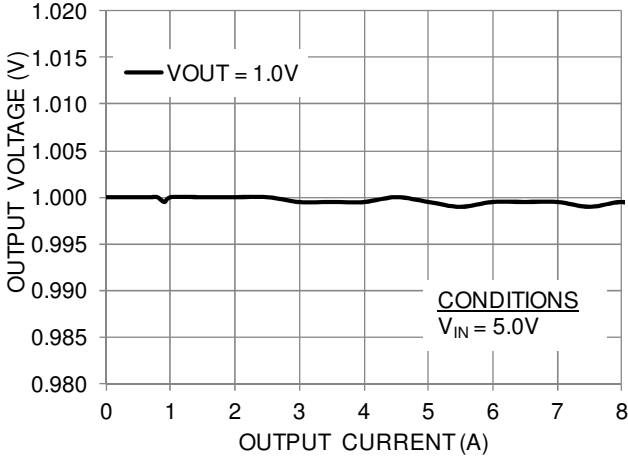

Output Voltage vs. Input Voltage

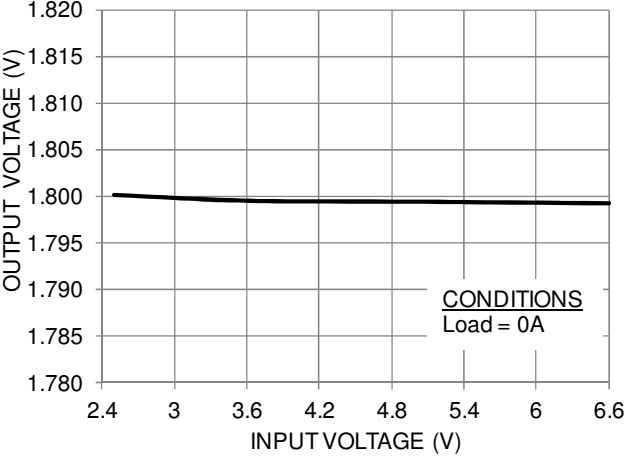

Output Voltage vs. Input Voltage

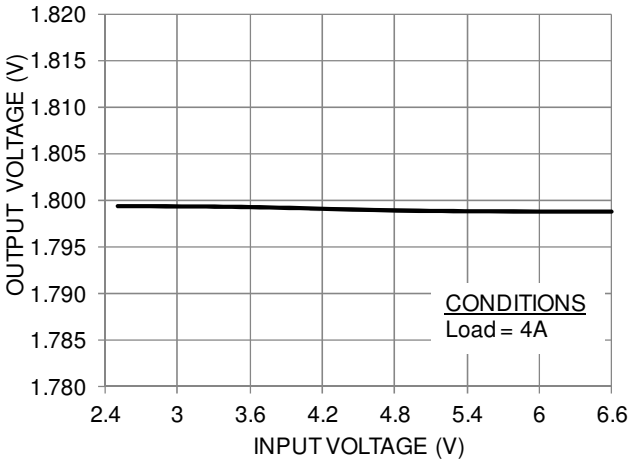

Output Voltage vs. Input Voltage

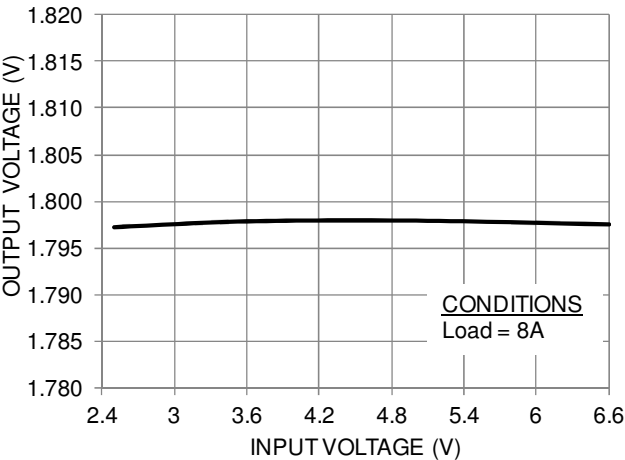

Output Voltage vs. Temperature

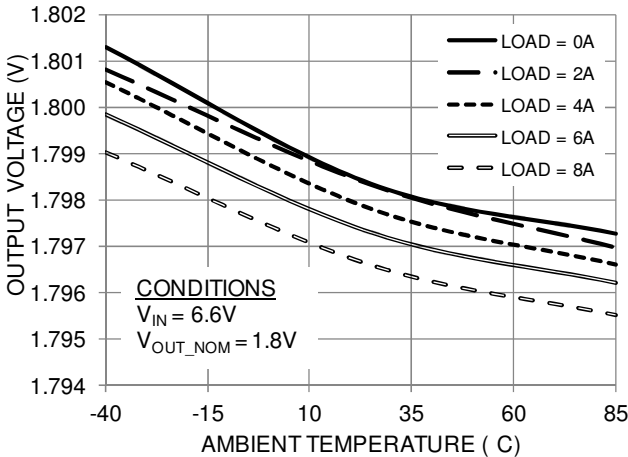

Output Voltage vs. Temperature

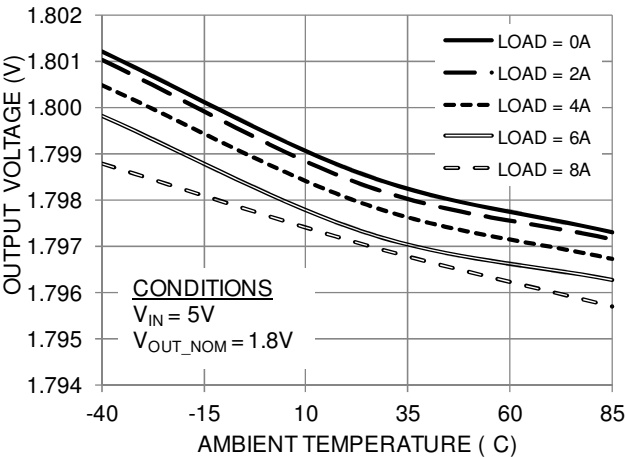

Typical Performance Curves (Continued)

Output Voltage vs. Temperature

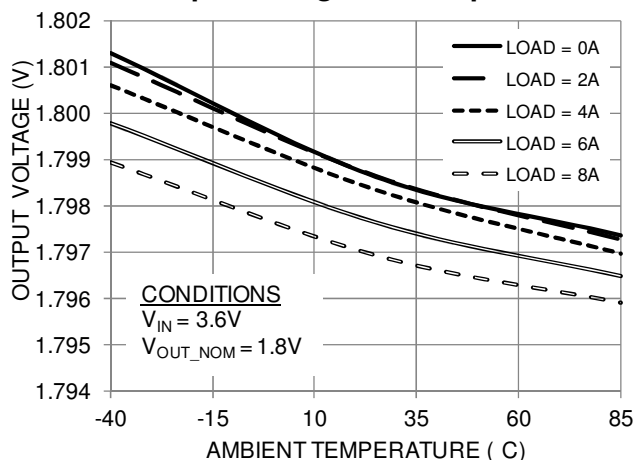

Output Voltage vs. Temperature

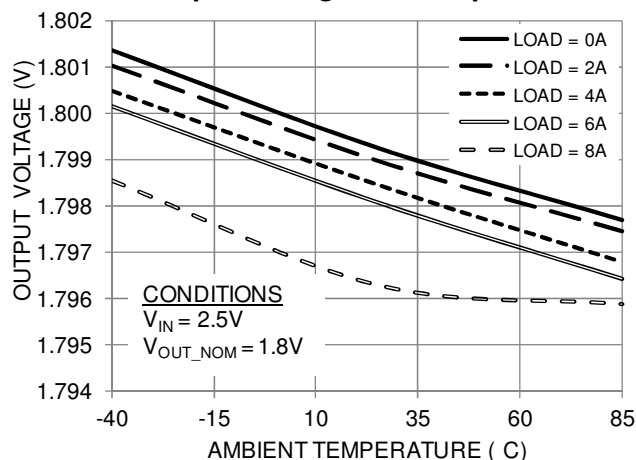

No Thermal Derating

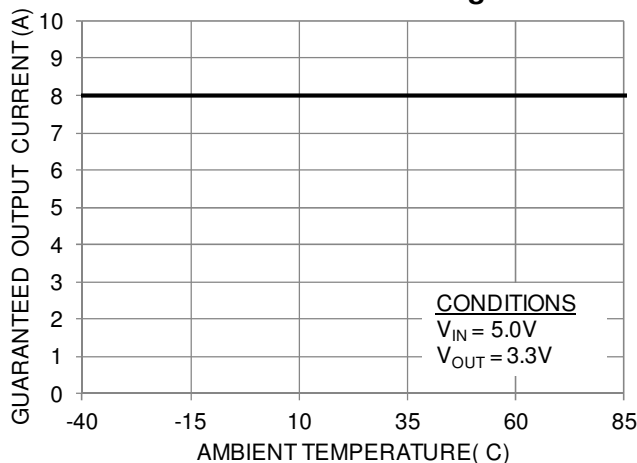

No Thermal Derating

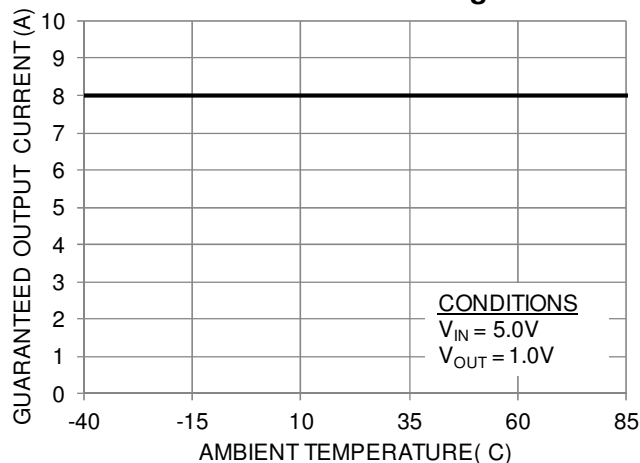

EMI Performance (Horizontal Scan)

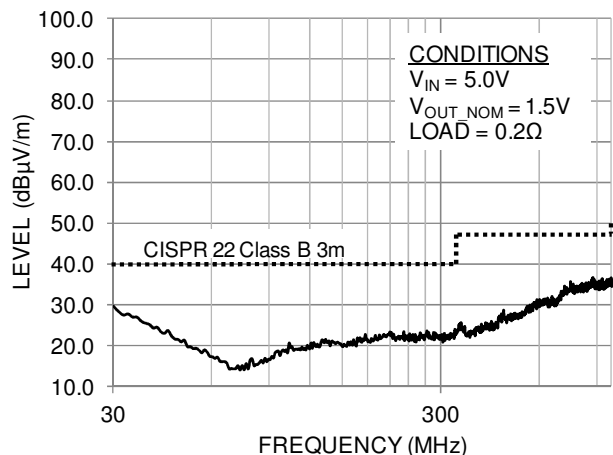

EMI Performance (Vertical Scan)

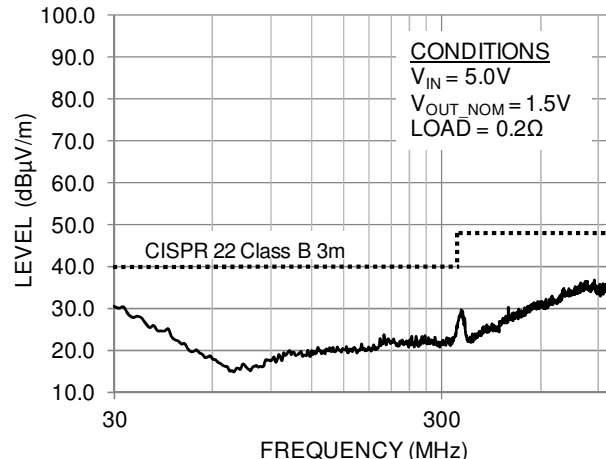

Typical Parallel Performance Curves

Parallel Efficiency vs. Output Current

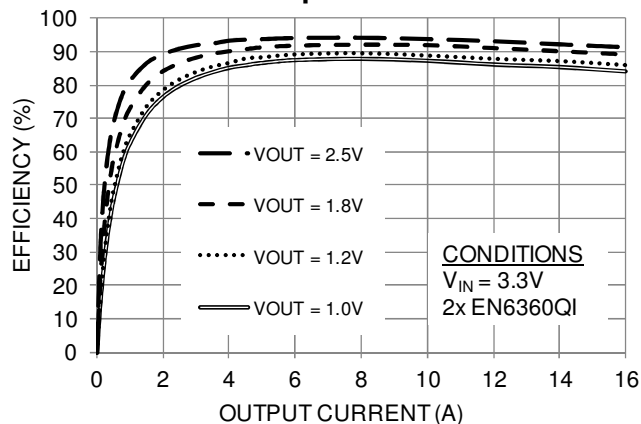

Parallel Efficiency vs. Output Current

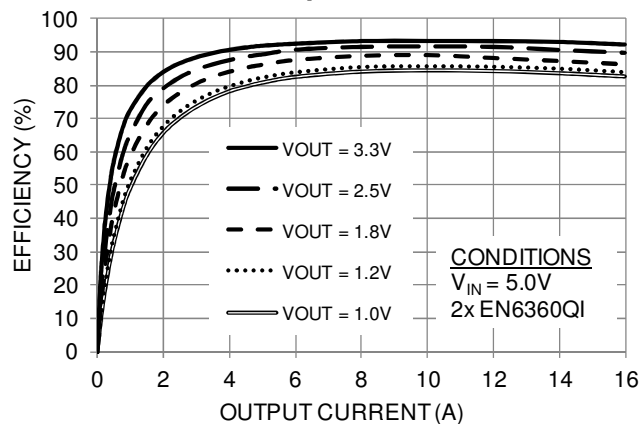

Parallel Current Share Mis-Match

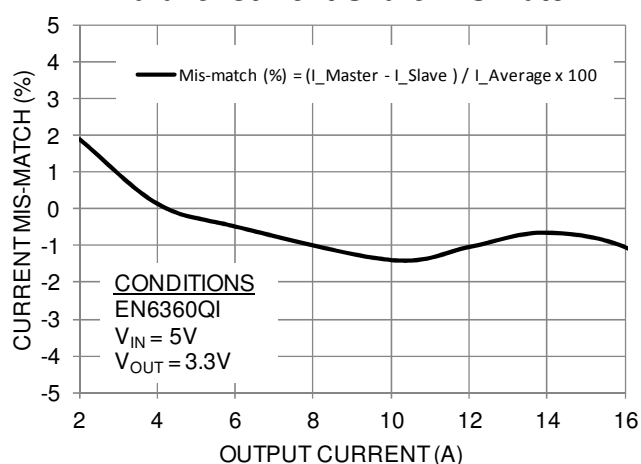

Parallel Current Share Breakdown

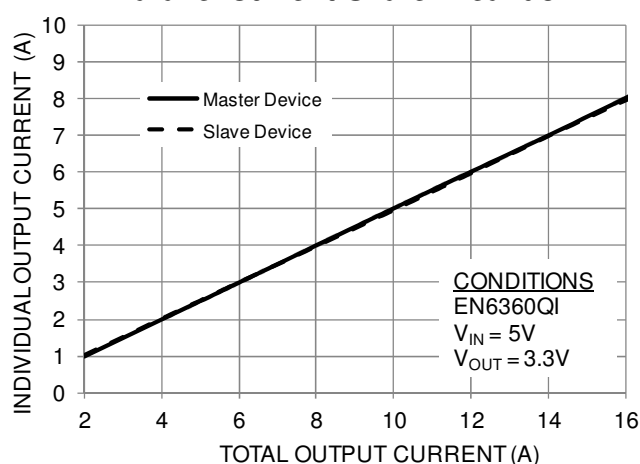

Parallel Output Voltage vs. Output Current

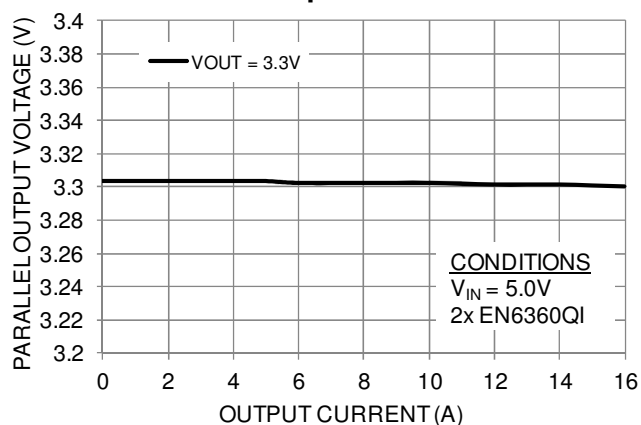

Parallel Output Voltage vs. Output Current

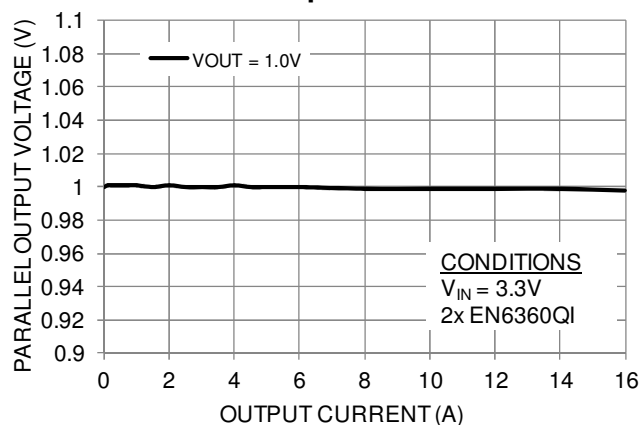

Typical Performance Characteristics

Output Ripple at 20MHz Bandwidth

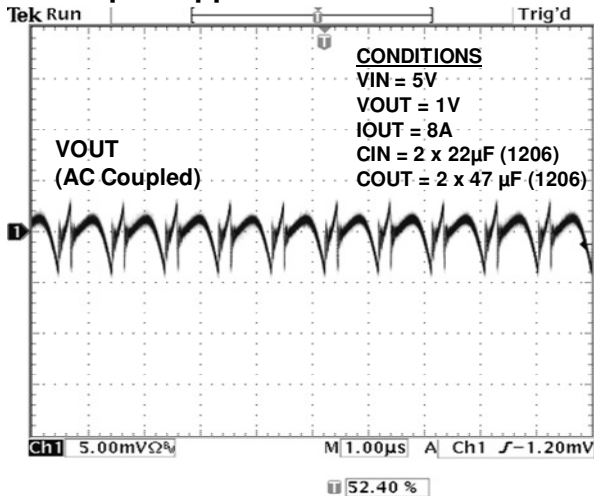

Output Ripple at 500MHz Bandwidth

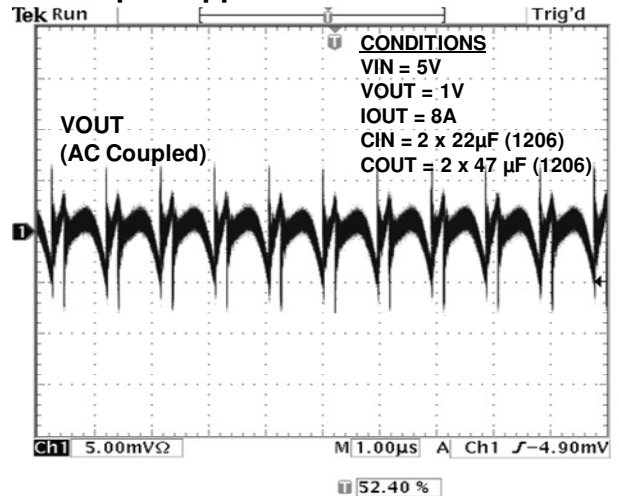

Output Ripple at 20MHz Bandwidth

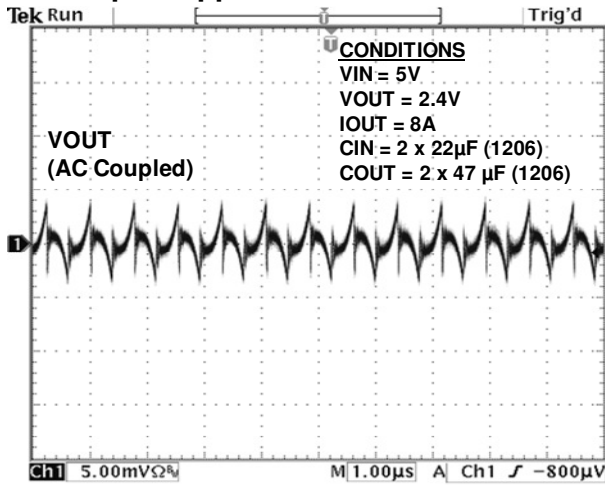

Output Ripple at 500MHz Bandwidth

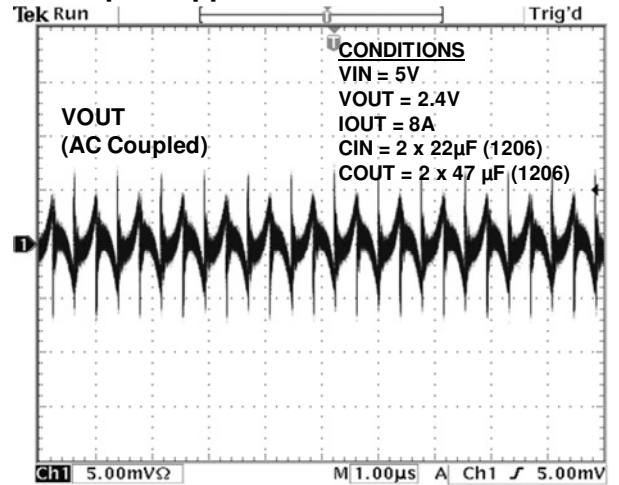

Enable Power Up/Down

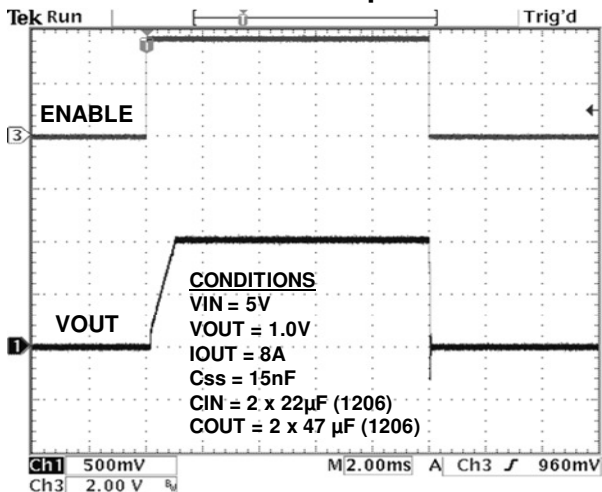

Enable Power Up/Down

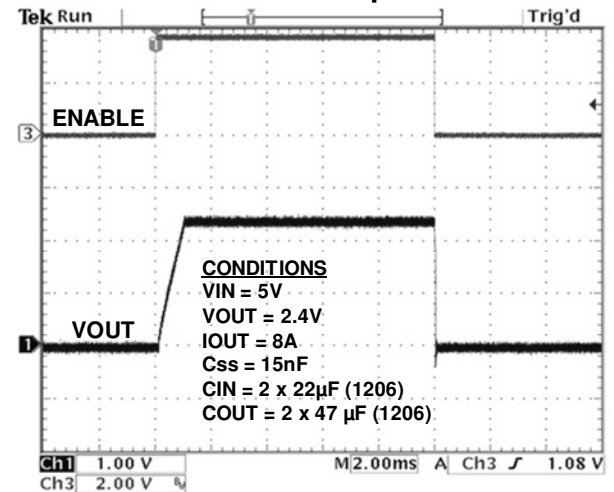

Typical Performance Characteristics (Continued)

Enable/Disable with POK

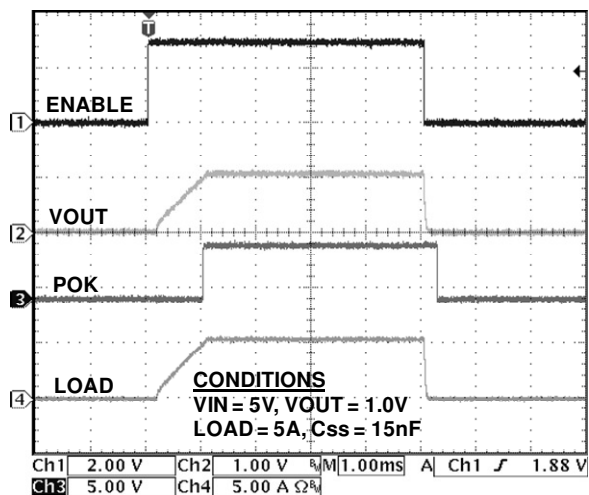

Load Transient from 0 to 8A

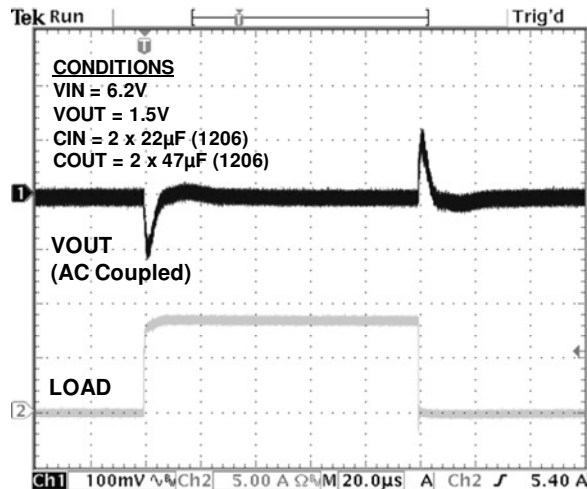

Parallel Operation SW Waveforms

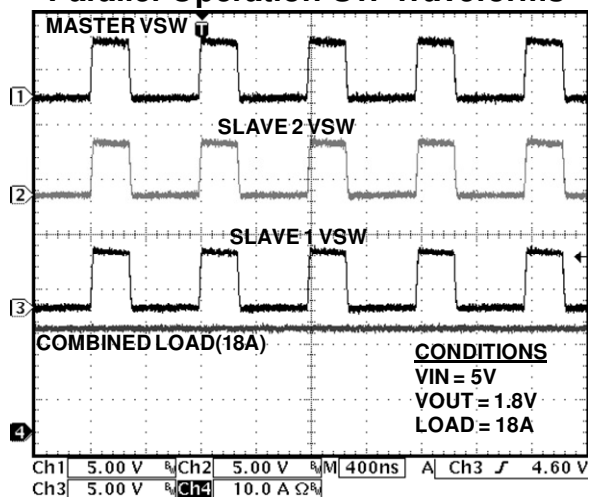

Parallel Operation Current Sharing

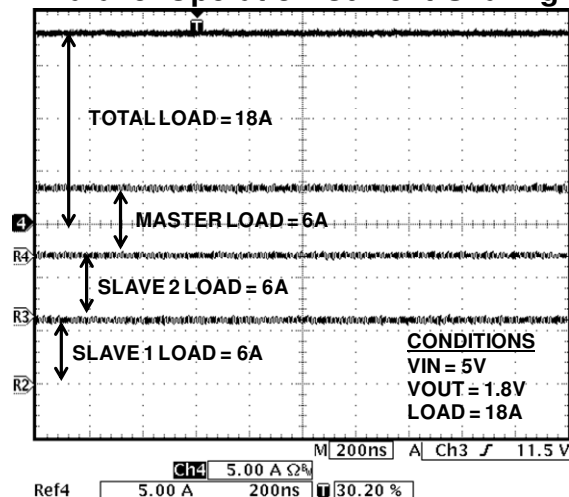

Functional Block Diagram

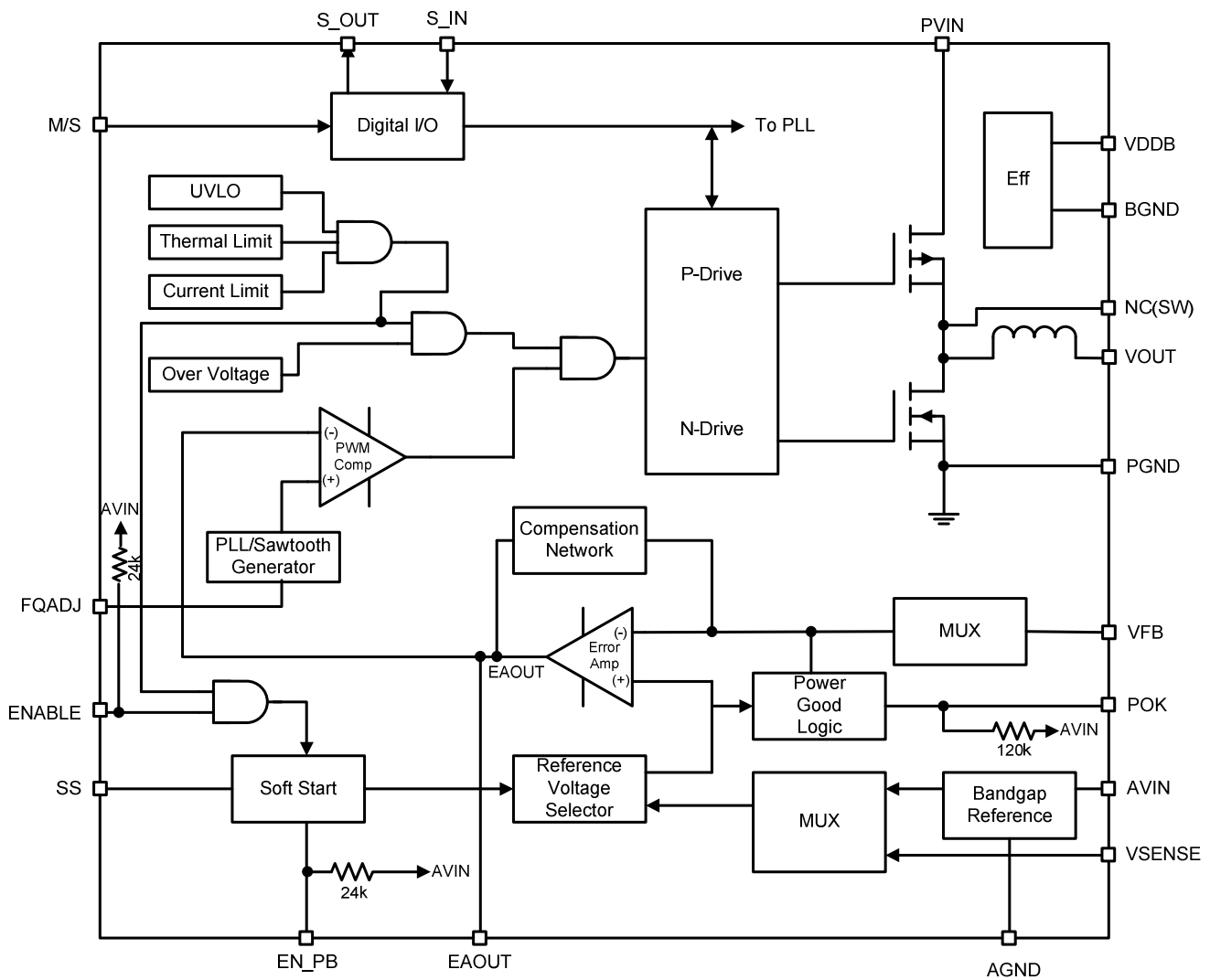

Figure 4: Functional Block Diagram

Functional Description

The EN6360QI is a synchronous, programmable buck power supply with integrated power MOSFET switches and integrated inductor. The switching supply uses voltage mode control and a low noise PWM topology. This provides superior impedance matching to ICs processed in sub 90nm process technologies. The nominal input voltage range is 2.5 - 6.6 volts. The output voltage is programmed using an external resistor divider network. The feedback control loop incorporates a type IV voltage mode control design. Type IV voltage mode control maximizes control loop bandwidth and maintains excellent phase margin to improve transient performance. The EN6360QI is designed to support up to 8A continuous output current operation. The operating switching frequency is between 0.9MHz and 1.5MHz and enables the use of small-size input and output capacitors.

The power supply has the following features:

- Precision Enable Threshold
- Soft-Start
- Pre-bias Start-Up
- Resistor Programmable Switching Frequency
- Phase-Lock Frequency Synchronization
- Parallel Operation
- Power OK
- Over-Current/Short Circuit Protection
- Thermal Shutdown with Hysteresis
- Under-Voltage Lockout

Precision Enable

The ENABLE threshold is a precision analog voltage rather than a digital logic threshold. A precision voltage reference and a comparator circuit are kept powered up even when ENABLE is de-asserted. The narrow voltage gap between ENABLE Logic Low and ENABLE Logic High allows the device to turn on at a precise enable voltage level. With the enable threshold pinpointed, a proper choice of soft-start capacitor helps to accurately sequence multiple power supplies in a system as desired. There is an ENABLE lockout time of 2ms that prevents the device from re-enabling immediately after it is disabled.

Soft-Start

The SS pin in conjunction with a small external

capacitor between this pin and AGND provides a soft-start function to limit in-rush current during device power-up. When the part is initially powered up, the output voltage is gradually ramped to its final value. The gradual output ramp is achieved by increasing the reference voltage to the error amplifier. A constant current flowing into the soft-start capacitor provides the reference voltage ramp. When the voltage on the soft-start capacitor reaches 0.60V, the output has reached its programmed voltage. Once the output voltage has reached nominal voltage the soft-start capacitor will continue to charge to 1.5V (Typical). The output rise time can be controlled by the choice of soft-start capacitor value.

The rise time is defined as the time from when the ENABLE signal crosses the threshold and the input voltage crosses the upper UVLO threshold to the time when the output voltage reaches 95% of the programmed value. The rise time (t_{RISE}) is given by the following equation:

$$t_{RISE} [\text{ms}] = C_{SS} [\text{nF}] \times 0.065$$

The rise time (t_{RISE}) is in milliseconds and the soft-start capacitor (C_{SS}) is in nano-Farads. The soft-start capacitor should be between 10nF and 100nF.

Pre-Bias Start-up

The EN6360QI supports startup into a pre-biased load. A proprietary circuit ensures the output voltage rises up from the pre-bias value to the programmed output voltage. Start-up is guaranteed to be monotonic for pre-bias voltages in the range of 20% to 75% of the programmed output voltage with a minimum pre-bias voltage of 300mV. Outside of the 20% to 75% range, the output voltage rise will not be monotonic. The Pre-Bias feature is automatically engaged with an internal pull-up resistor. For this feature to work properly, V_{IN} must be ramped up prior to ENABLE turning on the device. Tie VSENSE to VOUT if Pre-Bias is used. Tie EN_PB to ground and leave VSENSE floating to disable the Pre-Bias feature. Pre-Bias is supported for external clock synchronization, but not supported for parallel operations.

Resistor Programmable Frequency

The operation of the EN6360QI can be optimized by a proper choice of the R_{FQADJ} resistor. The frequency can be tuned to optimize dynamic performance and efficiency. Refer to Table 1 for recommended R_{FQADJ} values.

Table 1: Recommended R_{FQADJ} (k Ω)

V_{IN} \ V_{OUT}	0.8V	1.2V	1.5V	1.8V	2.5V	3.3V
3.3V $\pm 10\%$	3.57	3.57	4.99	5.49	5.49	NA
5.0V $\pm 10\%$	3.57	3.57	4.99	5.49	5.49	4.99
6.0V $\pm 10\%$	3.57	3.57	4.99	5.49	5.49	5.49

Phase-Lock Operation:

The EN6360QI can be phase-locked to an external clock signal to synchronize its switching frequency. The M/S pin can be left floating or pulled to ground to allow the device to synchronize with an external clock signal using the S_IN pin. When a clock signal is present at S_IN, an activity detector recognizes the presence of the clock signal and the internal oscillator phase locks to the external clock. The external clock could be the system clock or the output of another EN6360QI. The phase locked clock is then output at S_OUT. Refer to Table 2 for recommended clock frequencies.

Table 2: Recommended Clock fsw (MHz) $\pm 10\%$

V_{IN} \ V_{OUT}	0.8V	1.2V	1.5V	1.8V	2.5V	3.3V
3.3V $\pm 10\%$	1.15	1.15	1.30	1.35	1.35	NA
5.0V $\pm 10\%$	1.15	1.15	1.30	1.35	1.35	1.30
6.0V $\pm 10\%$	1.15	1.15	1.30	1.35	1.35	1.35

Master / Slave (Parallel) Operation and Frequency Synchronization

Multiple EN6360QI devices may be connected in a Master/Slave configuration to handle larger load currents. The device is placed in Master mode by pulling the M/S pin low or in Slave mode by pulling M/S pin high. **When the M/S pin is in float state, parallel operation is not possible.** In Master mode, a version of the internal switching PWM signal is output on the S_OUT pin. This PWM signal from the Master is fed to the Slave device at its S_IN pin. The Slave device acts like an extension of the power FETs in the Master and inherits the PWM frequency and duty cycle. The inductor in the Slave prevents crow-bar currents from Master to Slave due to timing delays. The Master device's switching clock may be phase-locked to an external clock source or another EN6360QI to move the entire parallel operation frequency away from sensitive frequencies. The feedback network for the Slave device may be left open. Additional Slave devices may be paralleled

together with the Master by connecting the S_OUT of the Master to the S_IN of all other Slave devices. Refer to Figure 5 for details.

Careful attention is needed in the layout for parallel operation. The VIN, VOUT and GND of the paralleled devices should have low impedance connections between each other. Maximize the amount of copper used to connect these pins and use as many vias as possible when using multiple layers. Place the Master device between all other Slaves and closest to the point of load.

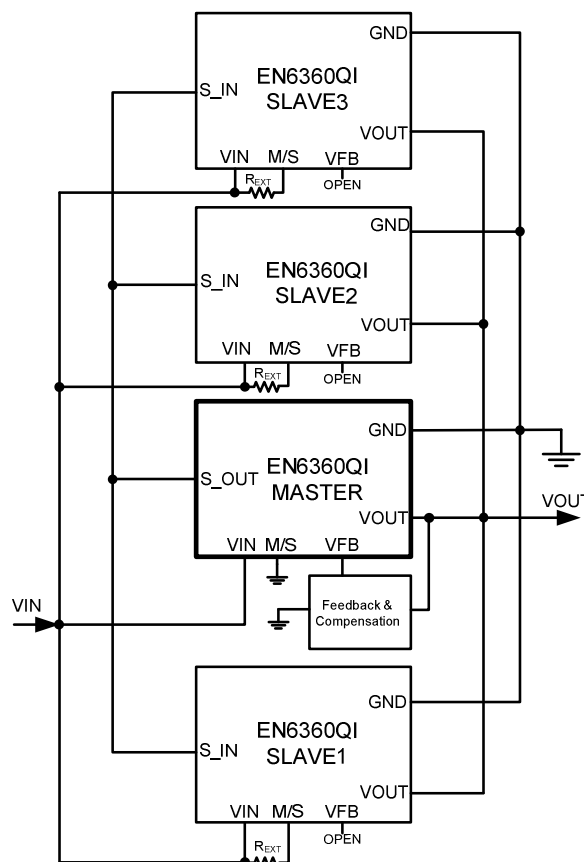
**Figure 5:** Master/Slave Parallel Operation Diagram

POK Operation

The POK signals that the output voltage is within the specified range. The POK signal is asserted high when the rising output voltage crosses 92% (nominal) of the programmed output voltage. If the output voltage falls outside the range of 90% to 120%, POK remains asserted for the de-glitch time (213 μ s at 1.2MHz). After the de-glitch time, POK is de-asserted. POK is also de-asserted if the output voltage exceeds 120% of the programmed output voltage.

Over Current Protection

The current limit function is achieved by sensing

the current flowing through a sense P-FET. When the sensed current exceeds the current limit, both power FETs are turned off for the rest of the switching cycle. If the over-current condition is removed, the over-current protection circuit will re-enable PWM operation. If the over-current condition persists, the circuit will continue to protect the load. The OCP trip point is nominally set as specified in the Electrical Characteristics table. In the event the OCP circuit trips consistently in normal operation, the device enters a hiccup mode. The device is disabled for 27 μ s and restarted with a normal soft-start. This cycle can continue indefinitely as long as the over current condition persists.

Thermal Overload Protection

Temperature sensing circuits in the controller will disable operation when the junction temperature exceeds approximately 150°C. Once the junction temperature drops by approx 20°C, the converter will re-start with a normal soft-start.

Input Under-Voltage Lock-Out

When the input voltage is below a required voltage level (V_{UVHI}) for normal operation, the converter switching is inhibited. The lock-out threshold has hysteresis to prevent chatter. Thus when the device is operating normally, the input voltage has to fall below the lower threshold (V_{UVLO}) for the device to stop switching.

Application Information

Output Voltage Programming and loop Compensation

The EN6360QI output voltage is programmed using a simple resistor divider network. A phase lead capacitor plus a resistor are required for stabilizing the loop. Figure 6 shows the required components and the equations to calculate their values.

The EN6360QI output voltage is determined by the voltage presented at the VFB pin. This voltage is set by way of a resistor divider between VOUT and AGND with the midpoint going to VFB.

The EN6360QI uses a type IV compensation network. Most of this network is integrated. However, a phase lead capacitor and a resistor are required in parallel with upper resistor of the external feedback network (Refer to Figure 6). Total compensation is optimized for use with two 47 μ F output capacitance and will result in a wide loop bandwidth and excellent load transient performance for most applications. Additional capacitance may be placed beyond the voltage sensing point outside the control loop. Voltage mode operation provides high noise immunity at light load. Furthermore, voltage mode control provides superior impedance matching to ICs processed in sub 90nm technologies.

In some cases modifications to the compensation or output capacitance may be required to optimize device performance such as transient response, ripple, or hold-up time. The EN6360QI provides the capability to modify the control loop response to allow for customization for such applications. For more information, contact Enpirion Applications Engineering support.

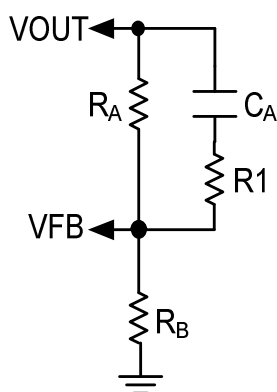

Figure 6: External Feedback/Compensation Network

The feedback and compensation network values depend on the input voltage and output voltage.

Calculate the external feedback and compensation network values with the equations below.

$$R_A [\Omega] = 48,400 \times V_{IN} [V]$$

*Round R_A up to closest standard value

$$R_B [\Omega] = (V_{FB} \times R_A) / (V_{OUT} - V_{FB}) [V]$$

$V_{FB} = 0.6V$ nominal

*Round R_B to closest standard value

$$C_A [F] = 3.83 \times 10^{-6} / R_A [\Omega]$$

*Round C_A down to closest standard value

$$R1 = 15k\Omega$$

The feedback resistor network should be sensed at the last output capacitor close to the device. Keep the trace to VFB pin as short as possible. Whenever possible, connect R_B directly to the AGND pin instead of going through the GND plane.

Input Capacitor Selection

The EN6360QI has been optimized for use with two 1206 22 μ F input capacitors. Low ESR ceramic capacitors are required with X5R or X7R dielectric formulation. Y5V or equivalent dielectric formulations must not be used as these lose capacitance with frequency, temperature and bias voltage.

In some applications, lower value ceramic capacitors may be needed in parallel with the larger capacitors in order to provide high frequency decoupling. The capacitors shown in the table below are typical input capacitors. Other capacitors with similar characteristics may also be used.

Table 3: Recommended Input Capacitors

Description	MFG	P/N
22 μ F, 10V, 20% X5R, 1206 (2 capacitors needed)	Murata	GRM31CR61A226ME19L
	Taiyo Yuden	LMK316BJ226ML-T

Output Capacitor Selection

The EN6360QI has been optimized for use with two 1206 47 μ F output capacitors. Low ESR, X5R or X7R ceramic capacitors are recommended as the primary choice. Y5V or equivalent dielectric formulations must not be used as these lose capacitance with frequency, temperature and bias voltage. The capacitors shown in the Recommended Output Capacitors table are typical output capacitors. Other capacitors with similar characteristics may also be used. Additional bulk

capacitance from 100 μ F to 1000 μ F may be placed beyond the voltage sensing point outside the control loop. This additional capacitance should have a minimum ESR of 6m Ω to ensure stable operation. Most tantalum capacitors will have more than 6m Ω of ESR and may be used without special care. Adding distance in layout may help increase the ESR between the feedback sense point and the bulk capacitors.

Table 4: Recommended Output Capacitors

Description	MFG	P/N
47 μ F, 10V, 20% X5R, 1206 (2 capacitors needed)	Taiyo Yuden	LMK316BJ476ML-T
47 μ F, 6.3V, 20% X5R, 1206 (2 capacitors needed)	Murata	GRM31CR60J476ME19L
	Taiyo Yuden	JMK316BJ476ML-T
10 μ F, 6.3V, 10% X7R, 0805 (Optional 1 capacitor in parallel with 2x47 μ F)	Murata	GRM21BR70J106KE76L
	Taiyo Yuden	JMK212B7106KG-T

Output ripple voltage is primarily determined by the aggregate output capacitor impedance. Placing multiple capacitors in parallel reduces the impedance and hence will result in lower ripple voltage.

$$\frac{1}{Z_{Total}} = \frac{1}{Z_1} + \frac{1}{Z_2} + \dots + \frac{1}{Z_n}$$

Table 5: Typical Ripple Voltages

Output Capacitor Configuration	Typical Output Ripple (mVp-p)
2 x 47 μ F	<10mV

[†] 20 MHz bandwidth limit measured on Evaluation Board

M/S - Ternary Pin

M/S is a ternary pin. This pin can assume 3 states – A low state (0V to 0.7V), a high state (1.8V to VIN) and a float state (1.1V to 1.4V). Device operation is controlled by the state of the pin. The pins may be pulled to ground or left floating without any special care. When pulling high to VIN, a series resistor is recommended. The resistor value may be optimized to reduce the current drawn by the pin. The resistance should not be too high as in that case the pin may not recognize the high state. The recommend resistance (R_{EXT}) value is given in the following table.

Table 5: Recommended R_{EXT} Resistor

V_{IN} (V)	I_{MAX} (μ A)	R_{EXT} (k Ω)
2.5 – 4.0	117	15
4.0 – 6.6	88	51

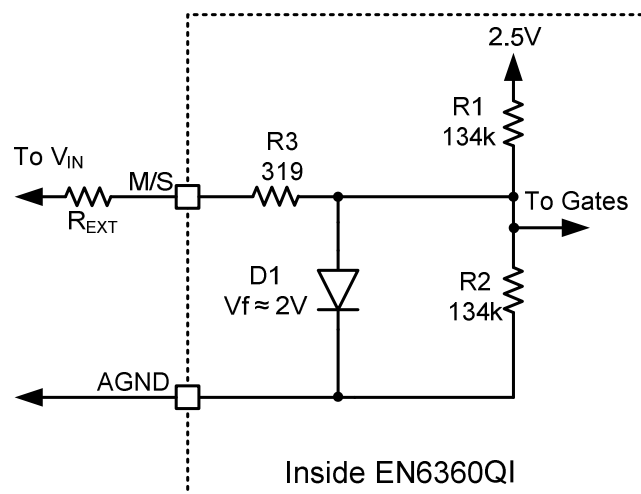

Figure 7: Selection of R_{EXT} to Connect M/S pin to V_{IN}

Table 6: M/S (Master/Slave) Pin States

M/S Pin	Function
Low (0V to 0.7V)	M/S pin is pulled to ground directly. This is the Master mode. Switching PWM phase will lock onto S_IN external clock if a signal is available. S_OUT outputs a version of the internal switching PWM signal.
Float (1.1V to 1.4V)	M/S pin is left floating. Parallel operation is not feasible. Switching PWM phase will lock onto S_IN external clock if a signal is available. S_OUT outputs a version of the internal switching PWM signal.
High (>1.8V)	M/S pin is pulled to VIN with R_{EXT} . This is the Slave mode. The S_IN signal of the Slave should connect to the S_OUT of the Master device. This signal synchronizes the switching frequency and duty cycle of the Master to the Slave device.

Power-Up Sequencing

During power-up, ENABLE should not be asserted before PVIN, and PVIN should not be asserted before AVIN. Tying all three pins together meets these requirements.

Technical Support

Contact Enpirion Applications for additional support regarding the use of this product (techsupport@enpirion.com).

Thermal Considerations

Thermal considerations are important power supply design facts that cannot be avoided in the real world. Whenever there are power losses in a system, the heat that is generated by the power dissipation needs to be accounted for. The Enpirion PowerSoC helps alleviate some of those concerns.

The Enpirion EN6360QI DC-DC converter is packaged in an 8x11x3mm 68-pin QFN package. The QFN package is constructed with copper lead frames that have exposed thermal pads. The exposed thermal pad on the package should be soldered directly on to a copper ground pad on the printed circuit board (PCB) to act as a heat sink. The recommended maximum junction temperature for continuous operation is 125°C. Continuous operation above 125°C may reduce long-term reliability. The device has a thermal overload protection circuit designed to turn off the device at an approximate junction temperature value of 150°C.

The EN6360QI is guaranteed to support the full 8A output current up to 85°C ambient temperature. The following example and calculations illustrate the thermal performance of the EN6360QI.

Example:

$$V_{IN} = 5V$$

$$V_{OUT} = 3.3V$$

$$I_{OUT} = 8A$$

First calculate the output power.

$$P_{OUT} = 3.3V \times 8A = 26.4W$$

Next, determine the input power based on the efficiency (η) shown in Figure 8.

For $V_{IN} = 5V$, $V_{OUT} = 3.3V$ at 8A, $\eta \approx 94\%$

$$\eta = P_{OUT} / P_{IN} = 94\% = 0.94$$

$$P_{IN} = P_{OUT} / \eta$$

$$P_{IN} \approx 26.4W / 0.94 \approx 28.085W$$

The power dissipation (P_D) is the power loss in the system and can be calculated by subtracting the output power from the input power.

$$P_D = P_{IN} - P_{OUT}$$

$$\approx 28.085W - 26.4W \approx 1.685W$$

With the power dissipation known, the temperature rise in the device may be estimated based on the theta JA value (θ_{JA}). The θ_{JA} parameter estimates how much the temperature will rise in the device for every watt of power dissipation. The EN6360QI has a θ_{JA} value of 15 °C/W without airflow.

Determine the change in temperature (ΔT) based on P_D and θ_{JA} .

$$\Delta T = P_D \times \theta_{JA}$$

$$\Delta T \approx 1.685W \times 15\text{°C/W} = 25.28\text{°C} \approx 25.3\text{°C}$$

The junction temperature (T_J) of the device is approximately the ambient temperature (T_A) plus the change in temperature. We assume the initial ambient temperature to be 25°C.

$$T_J = T_A + \Delta T$$

$$T_J \approx 25\text{°C} + 25.3\text{°C} \approx 50.3\text{°C}$$

With 1.685W dissipated into the device, the T_J will be 50.3°C.

The maximum operating junction temperature (T_{JMAX}) of the device is 125°C, so the device can operate at a higher ambient temperature. The maximum ambient temperature (T_{AMAX}) allowed can be calculated.

$$T_{AMAX} = T_{JMAX} - P_D \times \theta_{JA}$$

$$\approx 125\text{°C} - 25.3\text{°C} \approx 99.7\text{°C}$$

The ambient temperature can actually rise by another 74.7°C, bringing it to 99.7°C before the device will reach T_{JMAX} . This indicates that the EN6360QI can support the full 8A output current range up to approximately 99.7°C ambient temperature given the input and output voltage conditions. This allows the EN6360QI to guarantee full 8A output current capability at 85°C with room for margin. Note that the efficiency will be slightly lower at higher temperatures and this estimate will be slightly lower.

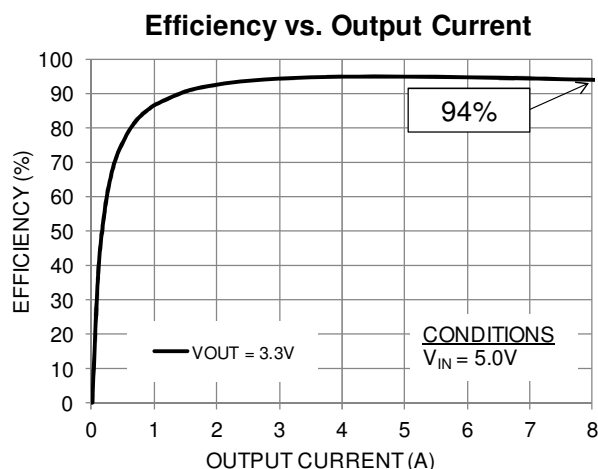

Figure 8: Efficiency vs. Output Current

Engineering Schematic

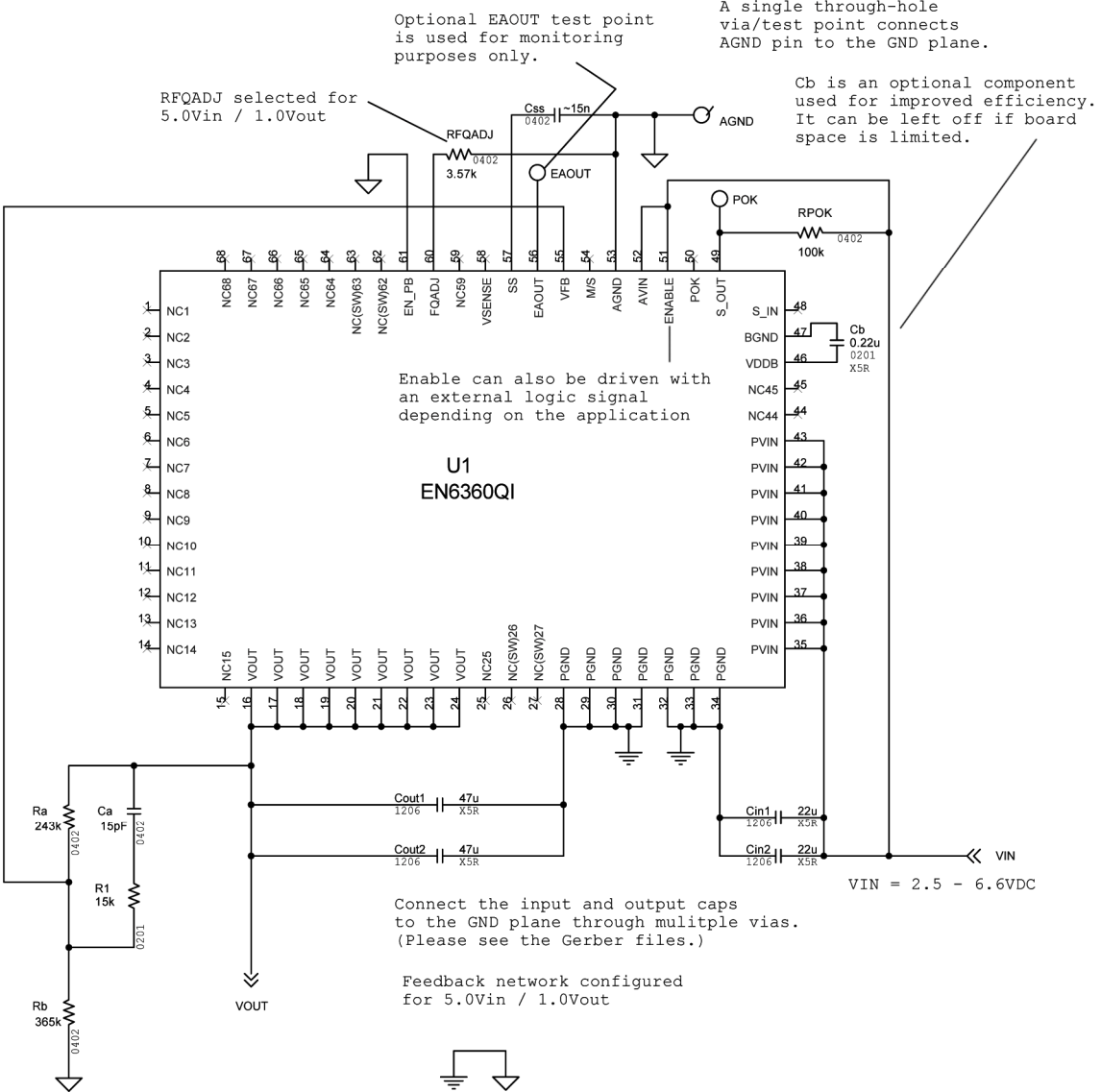

Figure 9: Engineering Schematic with Engineering Notes

Layout Recommendation

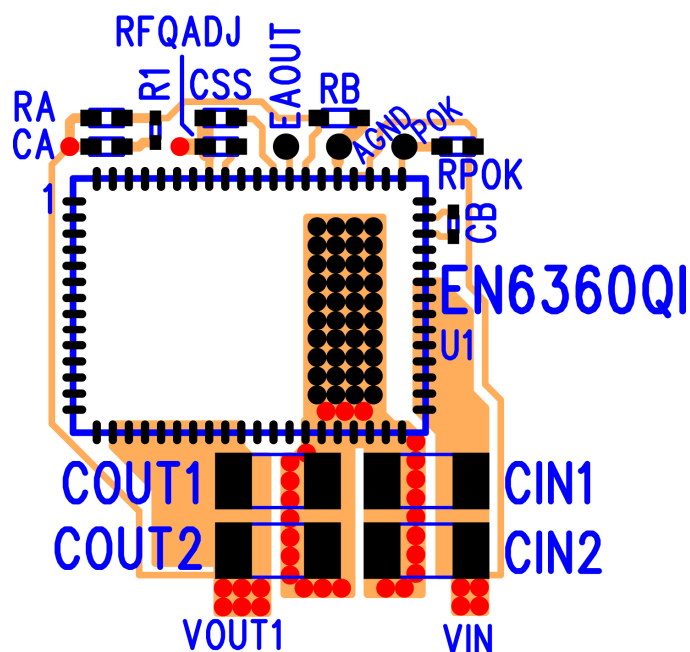

Figure 10: Top Layout with Critical Components Only (Top View). See Figure 9 for corresponding schematic.

This layout only shows the critical components and top layer traces for minimum footprint in single-supply mode with ENABLE tied to AVIN. Alternate circuit configurations & other low-power pins need to be connected and routed according to customer application. Please see the Gerber files at www.enpirion.com for details on all layers.

Recommendation 1: Input and output filter capacitors should be placed on the same side of the PCB, and as close to the EN6360QI package as possible. They should be connected to the device with very short and wide traces. Do not use thermal reliefs or spokes when connecting the capacitor pads to the respective nodes. The +V and GND traces between the capacitors and the EN6360QI should be as close to each other as possible so that the gap between the two nodes is minimized, even under the capacitors.

Recommendation 2: The PGND connections for the input and output capacitors on layer 1 need to have a slit between them in order to provide some separation between input and output current loops.

Recommendation 3: The system ground plane should be the first layer immediately below the surface layer. This ground plane should be continuous and un-interrupted below the converter and the input/output capacitors.

Recommendation 4: The thermal pad underneath the component must be connected to the system ground plane through as many vias as possible. The drill diameter of the vias should be 0.33mm, and the vias must have at least 1 oz. copper plating on the inside wall, making the finished hole size around 0.20-0.26mm. Do not use thermal reliefs or spokes to connect the vias to the ground plane. This connection provides the path for heat dissipation from the converter.

Recommendation 5: Multiple small vias (the same size as the thermal via discussed in recommendation 4) should be used to connect ground terminal of the input capacitor and output capacitors to the system ground plane. It is preferred to put these vias along the edge of the GND copper closest to the +V copper. These vias connect the input/output filter capacitors to the GND plane, and help reduce parasitic inductances in the input and output current loops.

Recommendation 6: AVIN is the power supply for the small-signal control circuits. It should be connected to the input voltage at a quiet point. In Figure 10 this connection is made at the input capacitor.

Recommendation 7: The layer 1 metal under the device must not be more than shown in Figure 10. Refer to the section regarding Exposed Metal on Bottom of Package. As with any switch-mode DC/DC converter, try not to run sensitive signal or control lines underneath the converter package on other layers.

Recommendation 8: The V_{OUT} sense point should be just after the last output filter capacitor. Keep the sense trace short in order to avoid noise coupling into the node.

Recommendation 9: Keep R_A , C_A , R_B , and R_1 close to the VFB pin (Refer to Figure 10). The VFB pin is a high-impedance, sensitive node. Keep the trace to this pin as short as possible. Whenever possible, connect R_B directly to the AGND pin instead of going through the GND plane.

Recommendation 10: Follow all the layout recommendations as close as possible to optimize performance. Enpirion provides schematic and layout reviews for all customer designs. Please contact local Sales Representatives for references to Enpirion Applications Engineering support.

Design Considerations for Lead-Frame Based Modules

Exposed Metal on Bottom of Package

Lead-frames offer many advantages in thermal performance, in reduced electrical lead resistance, and in overall foot print. However, they do require some special considerations.

In the assembly process lead frame construction requires that, for mechanical support, some of the lead-frame cantilevers be exposed at the point where wire-bond or internal passives are attached. This results in several small pads being exposed on the bottom of the package, as shown in Figure 11.

Only the thermal pad and the perimeter pads are to be mechanically or electrically connected to the PC board. The PCB top layer under the EN6360QI should be clear of any metal (copper pours, traces, or vias) except for the thermal pad. The “shaded-out” area in Figure 11 represents the area that should be clear of any metal on the top layer of the PCB. Any layer 1 metal under the shaded-out area runs the risk of undesirable shorted connections even if it is covered by soldermask.

The solder stencil aperture should be smaller than the PCB ground pad. This will prevent excess solder from causing bridging between adjacent pins or other exposed metal under the package. Please consult the Enpirion Manufacturing Application Note for more details and recommendations.

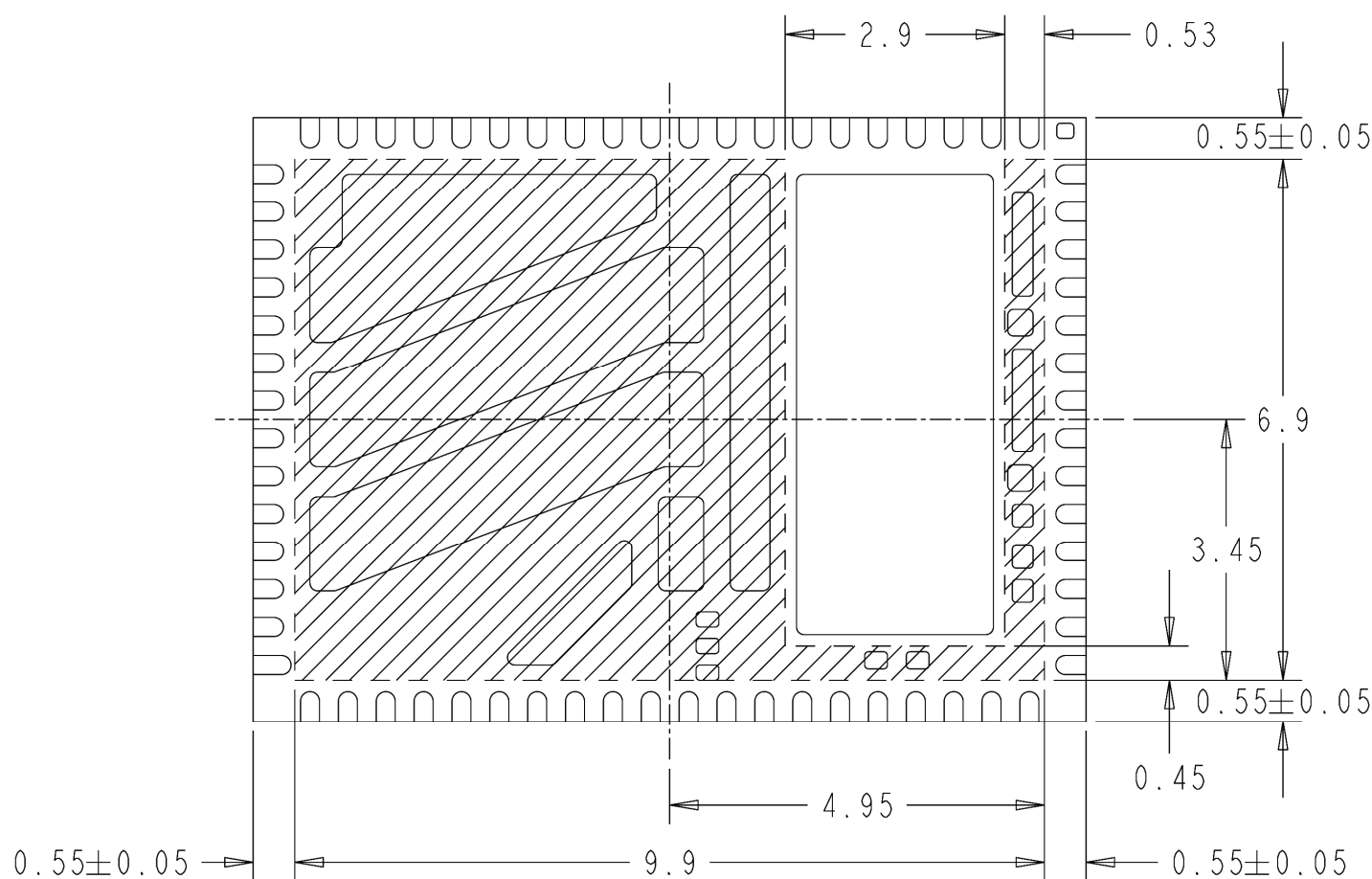

Figure 11: Lead-Frame exposed metal (Bottom View)

Shaded area highlights exposed metal that is not to be mechanically or electrically connected to the PCB.

Recommended PCB Footprint

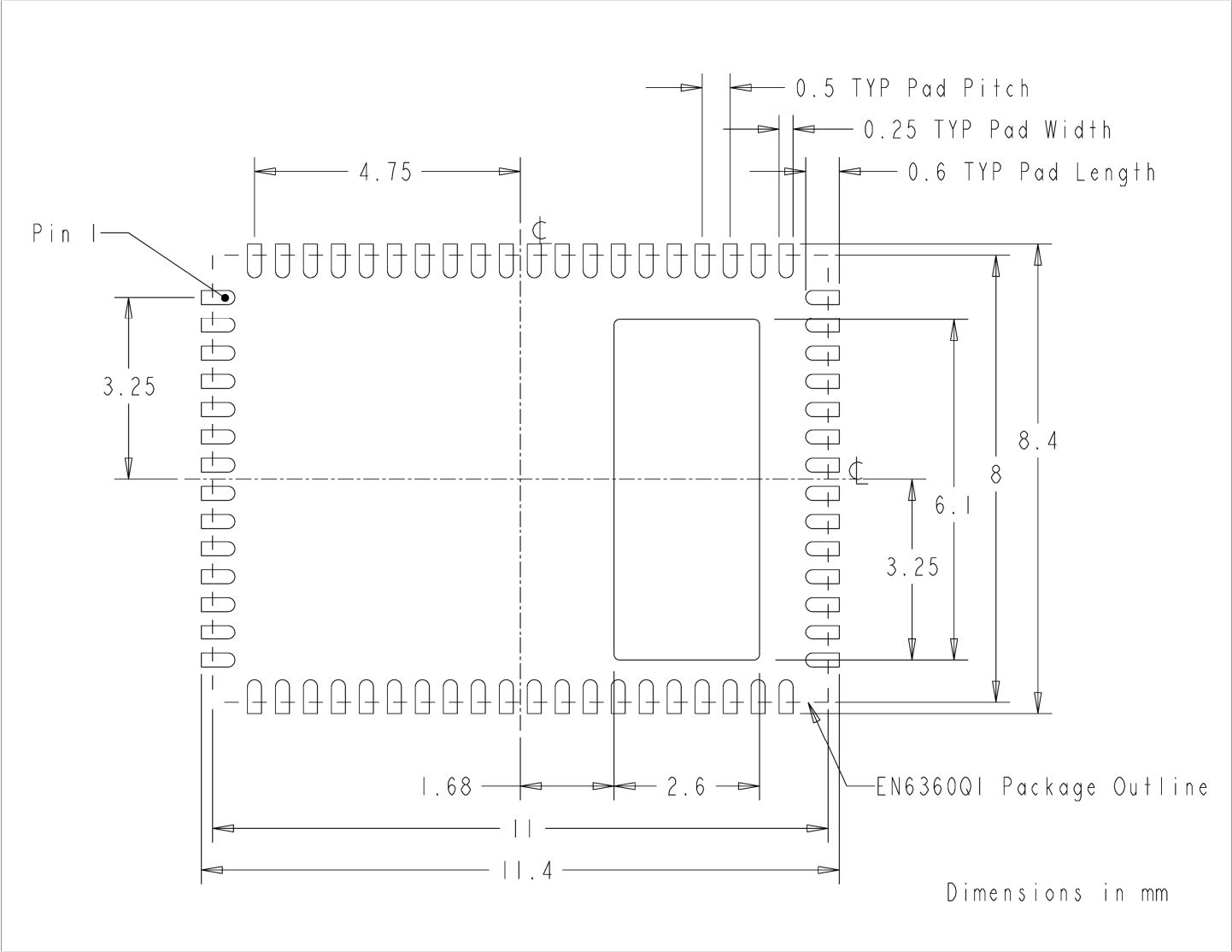

Figure 12: EN6360QI PCB Footprint (Top View)

Package and Mechanical

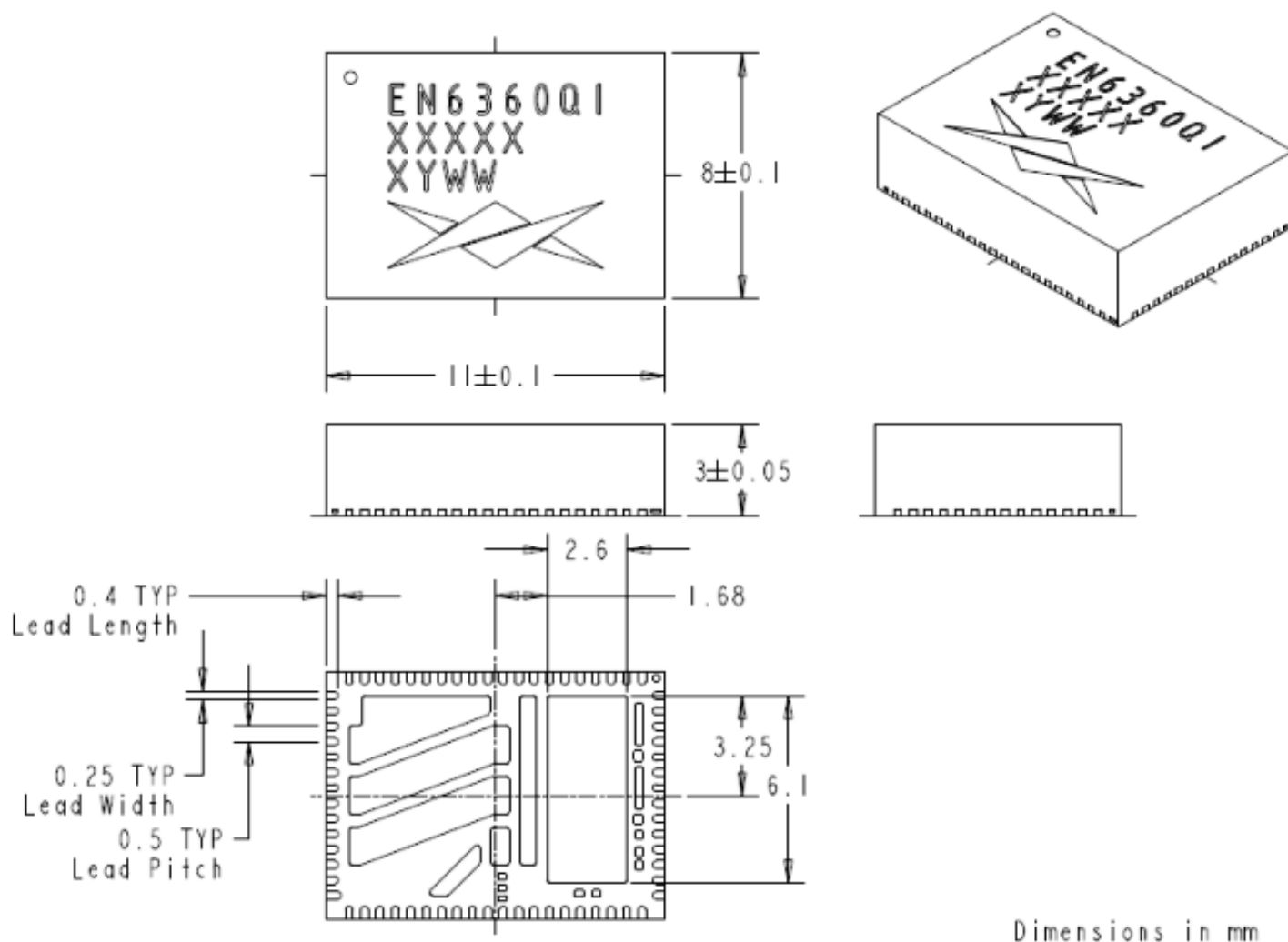

Figure 13: EN6360QI Package Dimensions (Bottom View)

Packing and Marking Information: <http://www.enpirion.com/resource-center-packing-and-marking-information.htm>

Contact Information

Enpirion, Inc.
 Perryville III Corporate Park
 53 Frontage Road - Suite 210
 Hampton, NJ 08827 USA
 Phone: 1.908.894.6000
 Fax: 1.908.894.6090

Enpirion reserves the right to make changes in circuit design and/or specifications at any time without notice. Information furnished by Enpirion is believed to be accurate and reliable. Enpirion assumes no responsibility for its use or for infringement of patents or other third party rights, which may result from its use. Enpirion products are not authorized for use in nuclear control systems, as critical components in life support systems or equipment used in hazardous environment without the express written authority from Enpirion